

# DF5450HD-DN/IR

Ultraline

Ultra High Definition Camera, 8 MP, 2160p/30, H.265, Day/Night, WDR, AI/VCA, Integrated IR Illumination, Motor-driven Varifocal Lens, PoE, Box Housing With Wall Mount Bracket



ONVIF | S



The DF5450HD-DN/IR has been designed especially for applications requiring **images with highest resolution in real-time** at day and in the IR mode at night. Built into an **IP66-rated weather-proof enclosure**, the camera is designed for both indoor and for outdoor applications.

## Ultra HD resolution

The **high resolution** of the sensor and the sophisticated **image processing** enable real-time recordings with **UHD resolution** at a **frame rate up to 25/30 fps** (2160p/30) with excellent quality. Thus, the camera is ideally suited when capturing the **finest detail** is required **in real time**.

## H.265 Support

The cameras are equipped with encoder technology that supports encoding of the video stream according to the H.265 standard. This allows the **data rate** to be **reduced by up to 50%** compared to H.264 with the same resolution and image quality. In conjunction with the latest Dallmeier recording systems, a **significant reduction in network and storage utilization** can be achieved.

## Motor-driven varifocal lens with P-Iris

The camera has a **motor-driven varifocal lens** that is perfectly tuned to the image sensor. The adjustment of **zoom, focus and iris** is made conveniently using a **web browser**. The manual lens setting directly at the installation site of the camera is not required.

## Digital Image Shift

The **Digital Image Shift** function allows **digital fine alignment of the image section** conveniently **using a web browser**. This ensures a quick and easy installation of the camera. The manual fine alignment of the camera directly at the installation site is not necessary.

## Video Content Analysis

The integrated **Video Content Analysis (VCA)** detects **movements and objects** in the uncompressed image and analyzes them in real-time (depending on the analysis resolution) with highly developed analysis functions such as **Intrusion Detection** or **Line Crossing**. The detected **events** can be used to trigger the recording of a **SMAVIA recording system**. Together with the detected objects and the corresponding metadata, they are stored in a database. This allows the targeted search and evaluation of the recordings by **SMAVIA Viewing Client** with the **SmartFinder** function.

## AI support

The camera is equipped with encoder technology that enables **Video Content Analysis supported by AI** (Artificial Intelligence) functions **based on neural networks** in the camera. This provides a **significantly more powerful object classification** which finally allows an even more targeted evaluation of the recordings.







## EdgeStorage

The camera is equipped with a **RAM memory** that is used by the **EdgeStorage** function to store the video stream in case of a network failure (e.g. Spanning Tree, Bursts). When the network is restored, the **SmartBackfill** function ensures fast transmission to the **SMAVIA recording system**. This stores the video stream with high speed and then continues to record the live stream seamlessly.

## Further features

- Minimum illumination 0 lux (with IR LED On)
- Integrated homogeneous IR illumination
- Ambient light sensor and removable IR cut filter
- Automatic switching of presets for day and night
- Frame rate of 30 fps at 2160p
- Video compression H.264, H.265, MJPEG
- Functions for data protection and data security (GDPR-compliant)
- Voltage supply with PoE (Class 0)
- IP66-rated weather-proof enclosure

Ultra High Definition Camera, 8 MP, 2160p/30, H.265, Day/Night, WDR, AI/VCA, Integrated IR Illumination, Motor-driven Varifocal Lens, PoE, Box Housing With Wall Mount Bracket

<b>Camera</b>	
007285	 <p><b>DF5450HD-DN/IR</b> Ultra High Definition Camera, 8 MP, 2160p/30, H.265, day/night, WDR, AI/VCA, integrated IR illumination, motor-driven varifocal lens, PoE, box housing with wall mount bracket, F1.4 / 4 – 10 mm</p>
<b>Power Supply</b>	
004316	 <p><b>PoE Midspan 30 W</b> Midspan power supply unit, 1x Ethernet port, 10/100/1000Base-T, 802.3at, 802.3af, 30 W</p>
<b>Wall Mount</b>	
004386	 <p><b>WCPA - Support Plate Adapter<sup>1)</sup></b> Reinforcing support plate WCPA for adapting the wall brackets WBMA, WBOVA2 and IR housing wall mount bracket</p>
<b>Corner Mount</b>	
004390	 <p><b>WCWA - Corner Mount Adapter<sup>1)</sup></b> Corner mount adapter WCWA for corner mounting</p>
<b>Pole Mount 65 - 110 mm</b>	
004387	 <p><b>WSFPA - Pole Mount Adapter<sup>1)</sup></b> Pole mount adapter WSFPA for pole diameters 65 – 110 mm (2.6 – 4.3")</p>
<b>Pole Mount 210 - 225 mm</b>	
004386	 <p><b>WCPA - Support Plate Adapter<sup>1)</sup></b> Reinforcing support plate WCPA for adapting the wall brackets WBMA, WBOVA2 and IR housing wall mount bracket</p>
004388	 <p><b>DBHWGC - Pole Mount Adapter<sup>1)</sup></b> Pole mount adapter DBHWGC for pole diameters 210 – 225 mm (8.3 – 8.6")</p>

<sup>1)</sup> Note: The color of this mounting accessories (gray-white) differs from that of the IR camera / wall mount bracket (white).

Ultra High Definition Camera, 8 MP, 2160p/30, H.265, Day/Night, WDR, AI/VCA, Integrated IR Illumination, Motor-driven Varifocal Lens, PoE, Box Housing With Wall Mount Bracket

Sensor	
Type	1/1.7" CMOS
Number of sensor pixels	12 MP
Light sensitivity	IR LED OFF: <0.05 lux (F1.4, AGC ON) IR LED On: 0 lux
Dynamic range	92 dB
Signal to noise ration	> 50 dB

Lens	
Type	Motor-driven varifocal lens
Format / Mount	1/1.7" Board Lens
Focal length	4 – 10 mm
Iris range	F1.4 – Closed
Iris control	P-Iris (motor-driven)
Zoom / Focus control	Motor-driven
Minimum object distance	0.5 m
IR corrected	Yes
Available angles of view <sup>2)</sup> (H × V) at wide end	Approx. 110° × 80° @ 12 MP (4000 × 3000) @ 5 MP (2592 × 1920) @ 4 MP (2336 × 1744) @ 3 MP (2048 × 1536)  Approx. 105° × 56° @ 8 MP (3840 × 2160) @ 5.3 MP (3072 × 1728) @ 1080p (1920 × 1080) @ 720p (1280 × 720)
Available angles of view <sup>2)</sup> (H × V) at tele end	Approx. 44° × 33° @ 12 MP (4000 × 3000) @ 5 MP (2592 × 1920) @ 4 MP (2336 × 1744) @ 3 MP (2048 × 1536)  Approx. 42° × 23° @ 8 MP (3840 × 2160) @ 5.3 MP (3072 × 1728) @ 1080p (1920 × 1080) @ 720p (1280 × 720)

Format and Encoding	
Video standard	SDTV (PAL/NTSC) HDTV (SMPTE 296M, SMPTE 274M)
Resolution 4:3	12 MP (4000 × 3000) @ 12.5/15 fps 5 MP (2592 × 1920) @ 25/30 fps 4 MP (2336 × 1744) @ 25/30 fps 3 MP (2048 × 1536) @ 25/30 fps 1.5 MP (1440 × 1080) @ 25/30 fps 1.2 MP (1280 × 960) @ 25/30 fps 704 × 576, 704 × 480, 640 × 480 @ 25/30 fps
Resolution 16:9	8 MP (3840 × 2160, 2160p) @ 25/30 fps (Ultra High Definition) 5.3 MP (3072 × 1728) @ 25/30 fps 1080p (1920 × 1080) @ 25/30 fps 720p (1280 × 720) @ 25/30 fps
Video compression	H.264, H.265, MJPEG
Frame rate	Up to 30 fps
Video bit rate	1 – 50 Mbps, CBR (constant bit rate), VBR (variable bit rate), with priority setting for image quality <sup>3)</sup>
Video streaming	Up to 3 streams with different settings simultaneously
Audio compression	G.711
Audio bit rate	64 kbps
Live streaming transmission method	Unicast, Multicast
Number of live streams / clients	Up to 4 streams with up to 16 Mbps simultaneously

2) All specifications ±5%. Minor shadowing (vignetting) may occur at extreme wide end due to the construction and do not constitute a defect.  
3) If the total available bit rate is not sufficient, not the image quality but the number of frames is adjusted.

Ultra High Definition Camera, 8 MP, 2160p/30, H.265, Day/Night, WDR, AI/VCA, Integrated IR Illumination, Motor-driven Varifocal Lens, PoE, Box Housing With Wall Mount Bracket

Functions	
Day/Night switching	Ambient light sensing and removable IR cut filter (ICR), switching threshold level adjustable
Black-and-white mode	Automatic (at low light or in night mode), On, Off
Automatic Electronic Shutter	1/1 – 1/8000 s
Slow Shutter Limit	1/1 – 1/1000 s
Lens control	Zoom control (Tele – Wide), Focus control (Far – Near, One-Push AF), Iris control (P-Iris) via web browser
Digital flip function	Horizontal, vertical or both axes
Digital Image Shift	Horizontal and vertical
Digital Noise Reduction	3D-DNR (adjustable by 10 levels)
Exposure presets	Universal, Indoor, Fluorescent, Casino, Low-Light, User-Defined (with automatic day/night switching)
Exposure compensation	-2 EV (Exposure Value) to + 2 EV (adjustable by 200 levels)
Exposure metering	Average metering (light information from entire scene), center-weighted average metering, spot metering
Brightness adjustment	Automatic (ALC), Manual
Gain control	Automatic (AGC) with adjustable Gain Limit
White balance	Auto: ATW (Auto Tracking White Balance), One-Push AWB (Automatic White Balance) Fixed: 2800K, 4000K, 5000K, 6500K and 7500K
Privacy Zone Masking	Hiding/masking of up to 16 protected areas (up to 100% of the entire image)
Alarm notification	Via DaVid protocol to PGuard advance, via E-Mail and FTP image upload in preparation
Alarm trigger	Application restart, EdgeStorage status
Video Content Analysis <sup>4)</sup>	Intrusion Detection (detection of access to a defined area) Line Crossing (detection of a virtual line crossing) Tamper Detection (detection of manipulations on the camera) Object Classification (classification of objects with AI support) Face Detection (detection of faces) <sup>5)</sup>
Protocols	
Ethernet protocols	IPv4 (ARP, ICMP, IGMPv2/IGMPv3), UDP, TCP, LLDP, CDP (v1,v2), DSCP (QoS), DNS, DHCP, NTP, HTTP/HTTPS <sup>6)</sup> , RTSP/RTP/RTCP, SNMP (v1, v2c, v3)
Ethernet protocols in preparation	IPv6 (NDP, ICMPv6, MLDv1/MLDv2, SLAAC, RDNSS), UDPv6, TCPv6, DNSv6, DHCPv6, LDAP
Communication protocols	DaVid, DaVidS, ONVIF Profile S, SNMP (v1, v2c, v3)
Security	HTTPS <sup>6)</sup> encryption, SSL/TLS <sup>6)</sup> 1.2 (AES), network access control according to IEEE 802.1X <sup>6)</sup>
Connections	
Ethernet	1x RJ45, 10BASE-T/100BASE-TX PoE
IR Illumination	
Type	Semi-covert 850 nm high power LEDs
IR intensity	Adjustable
Photocell	Adjustable Day/Night switching threshold level
Range	Up to approx. 30 m
Beam angle	Up to approx. 90°
Electrical Data	
Voltage supply	PoE (Class 0)
PoE standard	IEEE 802.3af
Power consumption	Max. 12.95 W

4) Depending on the CPU load.

5) The function detects the presence of a face (Face Detection). The analysis of visible features and the link to person data (Face Recognition) are not supported.

6) This product includes software developed by the OpenSSL Project for use in the OpenSSL Toolkit (<http://www.openssl.org>) and cryptographic software written by Eric Young ([ey@cryptsoft.com](mailto:ey@cryptsoft.com)).

Ultra High Definition Camera, 8 MP, 2160p/30, H.265, Day/Night, WDR, AI/VCA, Integrated IR Illumination, Motor-driven Varifocal Lens, PoE, Box Housing With Wall Mount Bracket

Mechanical Data	
Dimensions (W × H × D)	Approx. 99 × 88 × 231 mm (3.9" × 3.5" × 9.1") without wall mount bracket
Weight	Approx. 2.2 kg (4.9 lb) with wall mount bracket
Adjustment	2-axes
IP rating	IP66
Color	White

Environmental Conditions	
Operating temperature	−40°C to +50°C (−40°F to 122°F), minimum start-up temperature: −30°C (−22°F)
Relative humidity	0% – 90% RH, non-condensing

Miscellaneous	
Ambient light sensor	Integrated
Microphone	Integrated
Local memory	50 MB RAM memory
Memory extension	microSDXC 32/64 GB, Class 10, UHS-I (optional)
Configuration and live video	Via web browser (all major platforms)
Languages	German, English
Programming interface	Open platform for integration into 3rd party systems using API and ActiveX <sup>7)</sup>
ONVIF compliance	Profile S
GDPR compliance	Supported

Approvals/Certifications	
Type	CE, FCC, UL, DIN EN 50130-4 compliant, IEC/EN 62471 compliant

7) ActiveX is a trademark or registered trademark of Microsoft Corporation headquartered in Redmond, Washington, USA

# DF5450HD-DN/IR

# Ultraline

Ultra High Definition Camera, 8 MP, 2160p/30, H.265, Day/Night, WDR, AI/VCA, Integrated IR Illumination, Motor-driven Varifocal Lens, PoE, Box Housing With Wall Mount Bracket

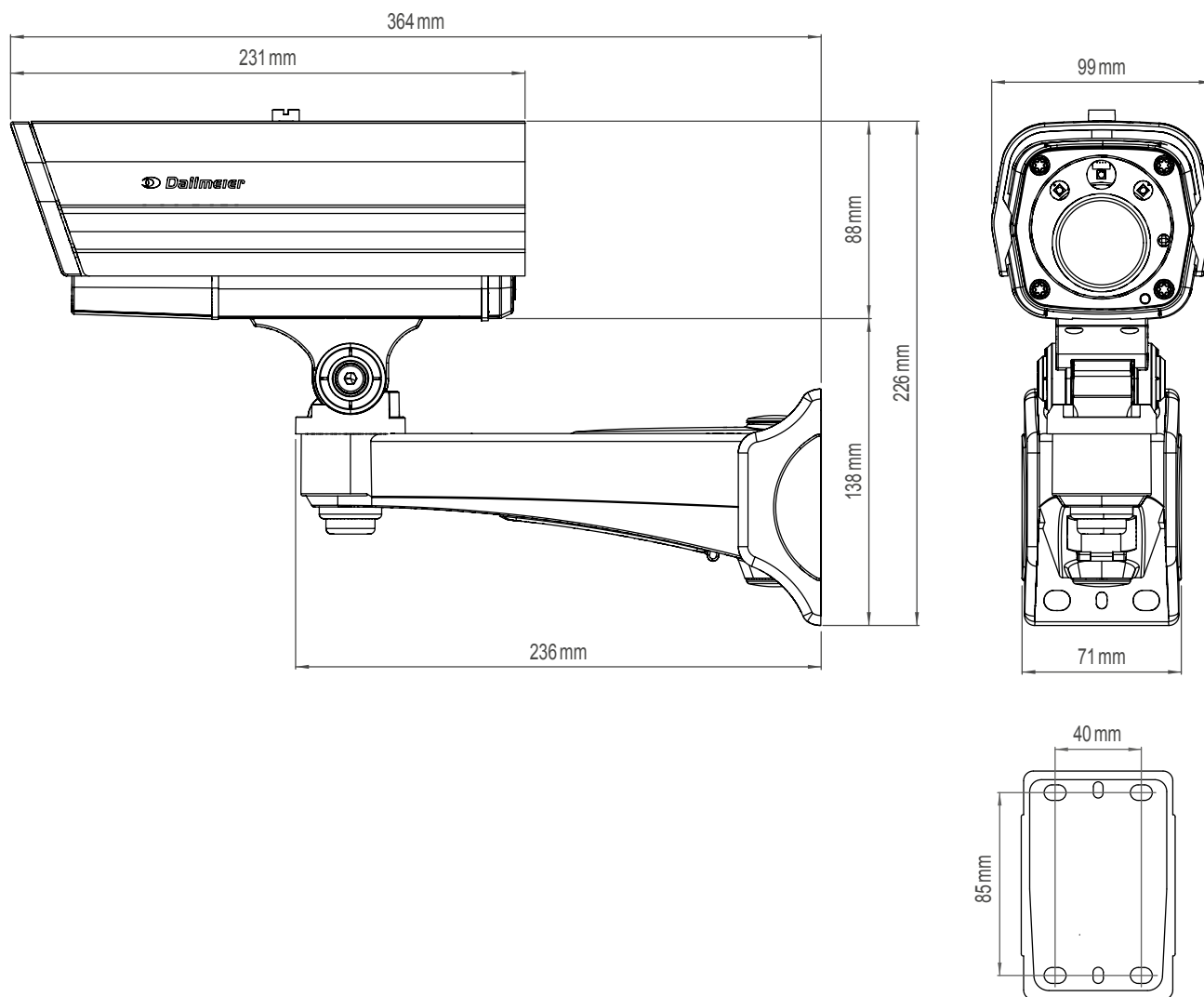

Dallmeier electronic GmbH & Co.KG | Bahnhofstr. 16, 93047 Regensburg, Germany | +49 941 8700-0 | [dallmeier.com](http://dallmeier.com)

All trademarks identified by \* are registered trademarks of Dallmeier electronic GmbH & Co.KG.

Third-party trademarks are named for information purposes only. Dallmeier electronic respects the intellectual property of third parties and always attempts to ensure the complete identification of third-party trademarks and indication of the respective holder of rights. In case that protected rights are not indicated separately, this circumstance is no reason to assume that the respective trademark is unprotected.

Specifications subject to change without notice. Errors and misprints excepted. Pictures may differ from the actual product.



See more.