

# IPS 10 000

SMAVIA appliance for the recording of up to 100 video streams, 3 RU rack-mount, storage system with 8x 3.5" HDD



The IPS 10 000 appliance combines the proven recording software SMAVIA Recording Server with a with reliable and high-performance server hardware. Perfectly tuned components ensure high storage speed and allow for the recording of up to 100 high-definition video streams at a frame rate of 30 fps. The integrated RAID 6 storage system already provides a high storage capacity and can be expanded by an external RAID 6 JBOD system. This makes the appliance the ideal recording system for larger video installations in stadiums, shopping malls, casinos or convention centres.

## Storage System

The IPS 10 000 has eight lockable bays for 3.5" hard disk drives on the front side. These are used exclusively for recording. The hardened Linux operating system and the SMAVIA Recording Server application are installed on a separate flash module. Fully equipped with the optionally offered 12 TB server hard disk drives, a RAID 6 storage capacity of 72 TB is available.

## SeMSy® Integration

The appliance is factory fitted with the SeMSy® Flat license. Thus, it is optimally equipped for integration into the storage system of a SeMSy® Video Management System. The appliance supports the complete SeMSy® functional range including convenient evaluation of recordings on a SeMSy® Workstation.

## SMAVIA Viewing Client

SMAVIA Viewing Client allows independent and convenient evaluation of the recordings over the network. The software can be installed on workstations with Windows operating system and adjusted individually. Two licenses for access with clients are already included in the scope of delivery of the appliance.

## PRemote-HD

The optional PRemote-HD function transcodes high-definition video streams (live and playback) for transmission in low-bandwidth networks. It allows the resource-conserving access with SeMSy® or SMAVIA Viewing Client which is independent of the recording settings. This license also includes the DMVC Server function for access with the mobile Dallmeier Mobile Video Center application.

## VCA Data Base

The appliance is equipped with a database for the analysis results of Dallmeier network cameras with VCA technology. The events, objects and classes sent by the camera are stored with the relevant metadata almost in real-time. SMAVIA Viewing Client is available for the targeted search and evaluation of the events with the SmartFinder function.

## SmartBackfill

Dallmeier network cameras are equipped with RAM memory that is used by the EdgeStorage function to store the video stream in case of a network failure (e.g. Spanning Tree, Bursts). When the network is restored, the SmartBackfill feature ensures fast transfer to the SMAVIA recording system. This stores the video stream at high speed and then seamlessly continues recording the live stream.

## Open Platform

The pre-installed SMAVIA Recording Server software is designed as an open platform. Together with the according licenses, third-party network cameras can be recorded with motion detection and configured over the ONVIF protocol.

## Features Hardware









- High performance server hardware
- Flash module for operating system and application
- Integrated RAID 6 storage system
- Optional RAID 6 JBOD storage expansion
- Optimized for high storage speed
- Redundant operation with optional PSU
- Mounting rails for 19" rack included in delivery

## Features SMAVIA Recording Server

- Recording of up to 100 high-resolution video streams
- Licenses for the recording of 32 video streams included
- Licenses for access with 2 clients included
- Licenses for the update of the software for 24 months included
- Recording of 3rd party network cameras optional
- Evaluation with DMVC App over WAN/LAN optional
- Evaluation with SMAVIA or SeMSy® over WAN/LAN
- Basic license for integrated data protection and data security module (GDPR-compliant) included

# IPS 10 000

SMAVIA appliance for the recording of up to 100 video streams,  
3 RU rack-mount, storage system with 8× 3.5" HDD

Appliance	
005753	 <b>IPS 10000</b> SMAVIA appliance for the recording of up to 100 video streams, licenses for the recording of 32 video streams included, licenses for the access with 2 clients included, without HDDs
Options Hardware	
000178	<b>Mounting of a HDD</b> Mounting of a HDD, incl. function, long-term-, and final test, acceptance and approval
006664	 <b>HDD 2000 GB, SATA, 3.5" <sup>1)</sup></b>
006158	<b>HDD 4000 GB, SATA, 3.5" <sup>1)</sup></b>
006596	<b>HDD 6000 GB, SATA, 3.5" <sup>1)</sup></b>
006632	<b>HDD 8000 GB, SATA, 3.5" <sup>1)</sup></b>
006961	<b>HDD 10000 GB, SATA, 3.5" <sup>1)</sup></b>
006962	<b>HDD 12000 GB, SATA, 3.5" <sup>1)</sup></b>
004064	 <b>DPM-150W</b> Power supply module 150 W, 115/230 V AC ±5%, 50/60 Hz
Option Network Contacts	
005142	<b>DLC - Ethernet I/O Interface for SMAVIA</b> License for the use of the software interface for the connection of the Ethernet I/O interfaces MOXA ioLogik E1210 (16 contacts), E1212 (8 contacts, 8 DIOs) or E1214 (6 contacts, 6 relays)
001739	 <b>Remote Ethernet I/O Interface</b> Ethernet I/O Interface, 2× Ethernet, 6× contact, 6× relay (MOXA ioLogik E1214)
Option Storage Expansion	
005756	<b>DLC - JBOD Storage Extension</b> License for the use of the software interface for the connection of a Storage JBOD storage extension
006180	 <b>MegaRAID Controller Kit</b> RAID controller board for the connection of a JBOD storage extension, CacheVault for the power supply of the cache in case of short-term power outages included, 12 Gbps SAS/SATA, available ex factory only
006945	 <b>Storage JBOD 12 II<sup>2)</sup></b> Storage system for the expansion of Dallmeier recording systems, 2 RU rack-mount, up to 12× 3.5" HDDs, 2× redundant power supplies, without HDDs
006946	 <b>Storage JBOD 24 II<sup>2)</sup></b> Storage system for the expansion of Dallmeier recording systems, 4 RU rack-mount, up to 24× 3.5" HDDs, 2× redundant power supplies, without HDDs
006949	 <b>Storage JBOD 44 II<sup>2)</sup></b> Storage system for the expansion of Dallmeier recording systems, 4 RU rack-mount, up to 44× 3.5" HDDs on front and rear side, 2× redundant power supplies, without HDDs

1) The appliance has to be equipped with at least 6 identical SATA hard disk drives in order to ensure the required storage speed.

2) The Storage JBOD has to be equipped with at least 6 identical SATA hard disk drives in order to ensure the required storage speed.  
The JBOD system has its own RAID system. A RAID array with the internal hard drives of the appliance is not supported.

# IPS 10 000

SMAVIA appliance for the recording of up to 100 video streams,  
3 RU rack-mount, storage system with 8x 3.5" HDD

## Included Licenses

### DLC - 32 Recording Channels

License for the recording of 32 high-definition video streams

### DLC - 2 Client Access

License for the simultaneous access of two clients to SMAVIA Recording Server (floating license)

### DCP - Software Maintenance 24 Months

License for the update of the SMAVIA software for 24 months

### DLC - SEDOR® Camera Sabotage Protection

License for detection and reporting of covering, defocusing and twisting of cameras

### DLC - SmartBackfill

License for the storage of video streams that have been buffered by Dallmeier network cameras with EdgeStorage (not available in combination with DLC - Bank Package and for cameras with recording mode Contact)

### DLC - SNMP

License for the integration into a central SNMP device management system

### DLC - SeMSy® Flat

License for the integration into a SeMSy® Video Management System

### DLC - Multicast Streaming

License for the transmission of video streams via multicast in a SeMSy® Video Management System

### DLC - Multicast Recording

License for the recording of video streams of Dallmeier network cameras using multicast transmission

### DLC - Real-Time Recording

License for real-time recording for all video streams (depending on the camera)

### DLC - RAID 6

License for the recording with RAID 6

### DLC - Data Protection and Data Security

Basic license for use of the integrated data protection and data security module (GDPR-compliant)

## Optional Licenses (Access)

**003782**     **DLC - 1 Additional Client Access**  
License for the simultaneous access of a further client on SMAVIA Recording Server (floating license)

**004068**     **DLC - 5 Additional Client Access**  
License for the simultaneous access of five further clients on SMAVIA Recording Server (floating license)

**004069**     **DLC - 10+ Additional Client Access (unlimited)**  
License for the simultaneous access of an unlimited number of clients on SMAVIA Recording Server, depending on system load and bandwidth (floating license)

## Optional Licenses (Channels)

**005754**     **DLC - 1 Additional Recording Channel (IPS 10 000)**  
License for the recording of a further high-definition video stream, maximum 100 video streams in total

**005755**     **DLC - 3rd Party Package for 1 Recording Channel (IPS 10 000)**  
License for the use of one existing channel for the recording (permanent, contact triggered or with motion detection) of third-party network cameras

# IPS 10 000

SMAVIA appliance for the recording of up to 100 video streams,  
3 RU rack-mount, storage system with 8x 3.5" HDD

Optional Licenses (Functions)	
003801	<b>DLC - PRemote-HD</b> License for the transmission of SD and HD video with low bandwidth, including a dedicated access license <sup>3)</sup> as well as the function for access with a mobile app (DMVC Server)
004685	<b>DLC - LAN Interface for Data Reception</b> License for the reception of the data from third-party systems (AWEK cash desk systems and NPC II protocol converter) over the network interface. Linking, storing and displaying the data with the video recordings included.
006293	<b>DLC - High-Speed Recording &gt;30 fps</b> License for the recording of Dallmeier network cameras with a frame rate of more than 30 fps
006899	<b>DLC - ViProxy Plus (IPS 10 000)</b> License for the use of the second network interface in conjunction with one of the functions ViProxy (physically separated network for cameras, WebConfig Routing included), Link Redundancy (redundant connection of the appliance to two switches) or Data Throughput (bundling of both network interfaces to a channel with double data throughput)
Maintenance and Warranty	
005974	<b>DCP - SW Maintenance 12 Months (IPS 10 000)</b> License for the update of the SMAVIA software for further 12 months, maximum 60 months in total
005975	<b>DCP - HW Warranty and SW Maintenance 36 Months (IPS 10 000)</b> Extension of the bring-in warranty period (without HDDs) to 36 months in total, and extension of the license for the update of the SMAVIA software to 36 months in total
005976	<b>DCP - HW Warranty and SW Maintenance 48 Months (IPS 10 000)</b> Extension of the bring-in warranty period (without HDDs) to 48 months in total, and extension of the license for the update of the SMAVIA software to 48 months in total
005977	<b>DCP - HW Warranty and SW Maintenance 60 Months (IPS 10 000)</b> Extension of the bring-in warranty period (without HDDs) to 60 months in total, and extension of the license for the update of the SMAVIA software to 60 months in total

3) The first PRemote client (master) is assigned active control over the PRemote stream; further PRemote clients (slaves) receive the stream passively.

# IPS 10 000

SMAVIA appliance for the recording of up to 100 video streams,  
3 RU rack-mount, storage system with 8× 3.5" HDD

Components	
CPU	Multi-Core
RAM	16 GB
Flash module	8 GB (for operating system and application)
Hard disks	Up to 8× 3.5" HDD (optional, note HDD whitelist, min. 7200 rpm and 128 MB cache)
Max. storage capacity	Currently up to 72 TB (RAID 6)
Fan	3× with automatic speed adaptation
Power supply unit 1	Integrated
Power supply unit 2	Integrated
Power supply unit 3	Optional (DPM-150W (004064), required for redundant operation)

Interfaces	
Video OUT	1× DisplayPort DP 1.2, only for configuration 1× DVI, only for configuration
AUX / Line IN	1× 3.5 mm phone jack
Microphone IN	1× 3.5 mm phone jack (for intercom, license 003801 required)
Audio OUT	1× 3.5 mm phone jack (for intercom, license 003801 required)
USB	2× USB 3.0 type A (rear side) 6× USB 2.0 type A (rear side) 1× USB 2.0 type A (front side)
Ethernet 1	RJ45, 10/100/1000 Mbps
Ethernet 2	RJ45, 10/100/1000 Mbps (optional, license DLC - ViProxy Plus (006899) required)
Contact IN	4×, with galvanic isolation, only for switch / push button (dry contact), with 4 functions each
Relay OUT	4×, with galvanic isolation, max. 12V DC / 24V AC / 0,5A, 150 mOhm, as NC or NO
SATA interface	RAID controller board for SMAVIA Enterprise Storage JBOD storage extension (optional)
PS/2	Mouse, keyboard

Protocols	
Ethernet protocols	IPv4 (ARP, ICMP, IGMPv2/IGMPv3), UDP, TCP
Ethernet protocols in preparation	IPv6 (NDP, ICMPv6, MLDv1/MLDv2, SLAAC, RDNS), UDPv6, TCPv6
Communication protocols	DaVid, DaVidS, HTTP, HTTPS <sup>4)</sup> , DNS, DHCP, LDAP, NTP, RTSP, RTP, RTCP, SNMP (v1, v2c)
Security	HTTPS <sup>4)</sup> encryption, SSL/TLS <sup>4)</sup> 1.2 (AES), network access control according to IEEE 802.1X <sup>4)</sup>

Electrical Data	
Voltage supply	115/230 V AC ±5%, 50/60 Hz
Power consumption	Max. 230 W
Thermal output	Max. 785 BTU/h

Mechanical Data	
Dimensions (W × H × D)	Approx. 483 × 133 × 533 mm (19.0" × 5.3" × 21.0")
Weight	Approx. 20 kg (44 lb) with eight hard disks
Color	Black (front, anodized)

Ambient Data	
Temperature	+ 5°C up to +40°C (41°F – 104°F)
Recommended temperature	+20°C up to + 25°C (68°F – 77°F)
Humidity	5 – 70% RH, non-condensing
Atmospheric load	Dust-free

Approvals and Certifications	
Type	CE, UL, FCC, RCM, LGC Forensics, DIN EN 50130-4

4) This product includes software developed by the OpenSSL Project for use in the OpenSSL Toolkit (<http://www.openssl.org>) and cryptographic software written by Eric Young ([ey@cryptsoft.com](mailto:ey@cryptsoft.com)).

# IPS 10 000

SMAVIA appliance for the recording of up to 100 video streams,  
3 RU rack-mount, storage system with 8x 3.5" HDD

Software	
Operating system	Linux (proprietary, hardened)
Application	SMAVIA Recording Server (version 9.x.x)
Application language	English, German, French, Spanish, Italian (others on request)
External management software	SMAVIA Viewing Client DMVC App (optional, license DLC - PRemote-HD (003801) required)
External configuration software	PService3
ONVIF compliance	Profile S
GDPR compliance	Supported

Performance in connection with IPS 10 000	
Channels	Up to 100x high definition video streams
Supported cameras	Dallmeier Panomera® multifocal sensor systems Dallmeier network cameras over TCP/DaVid (Dallmeier video protocol) Third-party network cameras with RTSP streaming over UDP/RTP or TCP (optional, license DLC - 3rd Party Package (005755) required)
Track mode	Automatic
Video/Audio compression	H.264, H.265 / G.722.1
Resolutions	Up to 12 MP, depending on the camera
Frame rate per channel	Up to 25/30 fps, depending on the camera
Bit rate per channel	Up to 50 Mbps, depending on the camera
Max. total bit rate	Up to 400 Mbps

Recording <sup>5)</sup>	3rd Party IP Camera	Dallmeier IP Camera
Transport protocol	RTP over UDP	TCP
Communications protocol	RTSP	DaVid
Mode Timer	integrated	integrated
Mode Permanent	integrated	integrated
Mode Contact	integrated	integrated
Mode Motion	integrated	integrated
Mode Motion/Contact	integrated	integrated
Switching mode by timer	--	integrated

Functions <sup>5)</sup>	3rd Party IP Camera	Dallmeier IP Camera
Motion detection	integrated	integrated
SmartFinder	integrated	integrated
Video proxy	integrated	integrated
SeMSy® multicast streamer	integrated	integrated
PRemote-HD	integrated	integrated
DMVC Server	integrated	integrated
PTZ control with SVC	integrated	integrated
Audio recording	integrated <sup>6)</sup>	integrated
Camera configuration	integrated	integrated
Locking the camera configuration	--	integrated
Recording multicast video streams	--	integrated
EdgeStorage&SmartBackfill	--	integrated
Network scan (IP Finder)	--	integrated
VCA data base	--	integrated

5) Data refer to a fully equipped appliance. Optional licenses are required.

6) Depending on the camera. The audio stream has to be supplied in the format G.711.

# IPS 10 000

SMAVIA appliance for the recording of up to 100 video streams,  
3 RU rack-mount, storage system with 8x 3.5" HDD

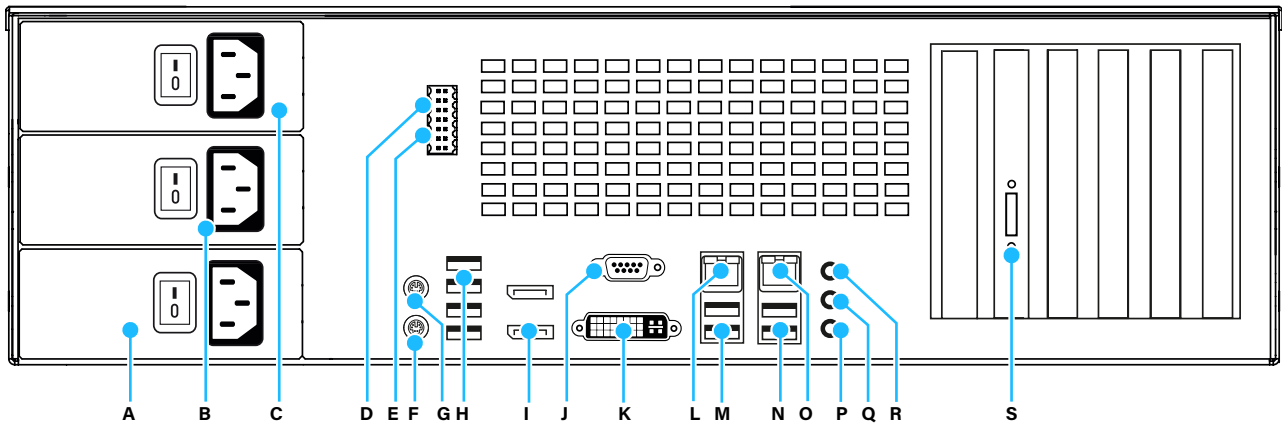

- |   |  |
|---|--|
| <p><b>A Power Supply Unit 1</b><br/>IEC C14 socket, 115/230V AC <math>\pm 5\%</math>, 50/60 Hz</p> <p><b>B Power Supply Unit 2</b><br/>IEC C14 socket, 115/230V AC <math>\pm 5\%</math>, 50/60 Hz</p> <p><b>C Power Supply Unit 3</b><br/>IEC C14 socket, 115/230V AC <math>\pm 5\%</math>, 50/60 Hz (optional)</p> <p><b>D Relay OUT (1-4)</b><br/>Weidmüller socket, 8 pins, max. 12V DC / 24V AC / 0,5A, 150 mOhm</p> <p><b>E Contact IN (1-4)</b><br/>Weidmüller socket, 6 pins, only for switch / push button (dry contact)</p> <p><b>F Keyboard</b><br/>PS/2, purple</p> <p><b>G Mouse</b><br/>PS/2, green</p> <p><b>H USB Interface</b><br/>4x USB 2.0, type A</p> <p><b>I Video OUT Interface</b><br/>2x DisplayPort (configuration)</p> <p><b>J Serial Interface COM 1</b><br/>D-SUB, 9 pins, 1x RS232</p> | <p><b>K Video OUT Interface</b><br/>DVI-D, Dual Link (24 + 5), 1920 x 1080 (configuration)</p> <p><b>L Ethernet Interface 2</b><br/>RJ45, 10/100/1000 Mbps (optional)</p> <p><b>M USB Interface</b><br/>2x USB 3.0, type A</p> <p><b>N USB Interface</b><br/>2x USB 2.0, type A</p> <p><b>O Ethernet Interface 1</b><br/>RJ45, 10/100/1000 Mbps</p> <p><b>P Microphone IN</b><br/>3.5 mm phone jack, red, 4.3kOhm, 2.828V<sub>pp</sub></p> <p><b>Q Audio OUT</b><br/>3.5 mm phone jack, green, 1kOhm, 2.828V<sub>pp</sub></p> <p><b>R AUX / Line IN</b><br/>3.5 mm phone jack, blue, 16kOhm, 2.828V<sub>pp</sub></p> <p><b>S SATA Interface</b><br/>RAID controller board for storage extension (optional)</p> |
|---|--|

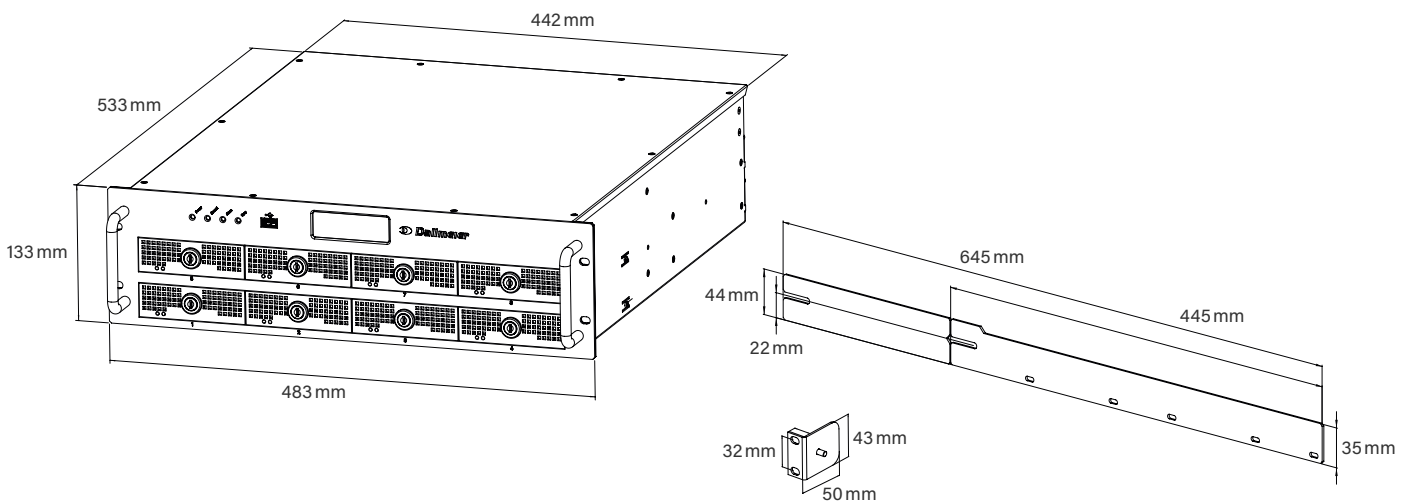

Dallmeier electronic GmbH & Co.KG | Bahnhofstr. 16, 93047 Regensburg, Germany | +49 941 8700-0 | dallmeier.com

All trademarks identified by \* are registered trademarks of Dallmeier electronic GmbH & Co.KG.

Third-party trademarks are named for information purposes only. Dallmeier electronic respects the intellectual property of third parties and always attempts to ensure the complete identification of third-party trademarks and indication of the respective holder of rights. In case that protected rights are not indicated separately, this circumstance is no reason to assume that the respective trademark is unprotected.

Specifications subject to change without notice. Errors and misprints excepted. Pictures may differ from the actual product.



See more.