

SeMSy® Recording Server for the recording of up to 120 video streams, MK2 revision, 3RU rack-mount, storage system with 8x 3.5" HDD



The IPS 10 000 appliance in the MK2 revision combines the recording software SeMSy® Recording Server (V10) with a reliable and high-performance server hardware. Perfectly matched components ensure high storage speed and allow the recording of up to 120 high-resolution video streams at a frame rate of 30 fps. The integrated RAID 6 storage system already provides a high storage capacity and can be expanded by an external RAID 6 JBOD system.

### Storage System

The IPS 10 000 has eight lockable bays for 3.5" hard disks on the front side, which are used for recording video streams and storing EdgeAnalytics data. The hardened Linux operating system and the SeMSy® Recording Server application are installed on a separate flash module. Fully equipped with the optionally offered 18 TB server hard disks, a RAID 6 storage capacity of 108 TB is available.

### SeMSy® Compact

SeMSy® Compact allows independent and convenient evaluation of the recordings over the network. The software can be installed on workstations with Windows operating system and adjusted individually. Two licenses for access with clients are already included in the scope of delivery of the appliance.

### PRemote-HD

The optional PRemote-HD function transcodes high-definition video streams (live and playback) for transmission in low-bandwidth networks. It allows the resource-conserving access with SeMSy® Compact or a SeMSy® Workstation which is independent of the recording settings. This license also includes the DMVC Server function for access with the mobile Dallmeier Mobile Video Center application.

### EdgeAnalytics Database

The appliance is equipped with a database for the analysis results of Dallmeier network cameras and Panomera® systems with Edge-Analytics technology. The received events, objects and classes are stored with the relevant metadata almost in real-time. SeMSy® Compact is available for the targeted search and evaluation of the events with the SmartFinder function.

### SmartBackfill

Dallmeier network cameras are equipped with RAM memory that is used by the EdgeStorage function to store the video stream in case of a network failure (e.g. Spanning Tree, Bursts). When the network is restored, the SmartBackfill feature ensures fast transfer to the SeMSy® recording system. This stores the video stream at high speed and then seamlessly continues recording the live stream.

### Open Platform

The pre-installed SeMSy® Recording Server software is designed as an open platform. Together with the according licenses, third-party network cameras can be recorded with motion detection and configured over the ONVIF protocol.









### Features Hardware

- High performance server hardware
- Flash module for operating system and application
- Integrated RAID 6 storage system
- Optional RAID 6 JBOD storage extension
- Optimized for high storage speed
- Redundant operation with three included power supplies
- Mounting rails for 19" rack included in delivery

### Features SMAVIA Recording Server

- Recording of up to 120 high-resolution video streams
- Licenses for the recording of 8 video streams included
- Licenses for access with two SeMSy® Compact clients included
- Licenses for the update of the software for 12 months included
- Recording of 3rd party network cameras optional
- ONVIF Profile S and Profile T supported
- Evaluation with DMVC App over WAN/LAN optional
- Evaluation with SeMSy® Compact/Workstation over WAN/LAN
- Basic license for integrated data protection and data security module (GDPR-compliant) included

SeMSy® Recording Server for the recording of up to 120 video streams,  
MK2 revision, 3 RU rack-mount, storage system with 8x 3.5" HDD

Appliance	
	<p><b>008051.402 IPS 10 000</b> SeMSy® Recording Server for the recording of up to 120 video streams, MK2 revision, licenses for the recording of 8 video streams included, licenses for the access with two SeMSy® Compact clients included, 3x redundant power supplies, without hard disk drives</p>
Hard Disk Drive	
	<p><b>000178 Mounting of a HDD</b> Mounting of a HDD, including functional, long-term and final test, acceptance and approval</p>
	<p><b>007521 HDD 2000 GB, SATA, 3.5" <sup>1)</sup></b></p>
	<b>007305 HDD 4000 GB, SATA, 3.5" <sup>1)</sup></b>
	<b>008445 HDD 6000 GB, SATA, 3.5" <sup>1)</sup></b>
	<b>007914 HDD 8000 GB, SATA, 3.5" <sup>1)</sup></b>
	<b>007988 HDD 10000 GB, SATA, 3.5" <sup>1)</sup></b>
	<b>008204 HDD 12000 GB, SATA, 3.5" <sup>1)</sup></b>
	<b>007800 HDD 14000 GB, SATA, 3.5" <sup>1)</sup></b>
	<b>007801 HDD 16000 GB, SATA, 3.5" <sup>1)</sup></b>
	<b>008055 HDD 18000 GB, SATA, 3.5" <sup>1)</sup></b>
Storage Extension	
	<p><b>005756 DLC - JBOD Storage Extension</b> License for the use of the software interface for the connection of a Storage JBOD storage extension</p>
	<p><b>006180 MegaRAID Controller Kit</b> RAID controller board for the connection of a JBOD storage extension, CacheVault for the power supply of the cache in case of short-term power outages included, 12 Gbps SAS/SATA, available ex factory only</p>
	<p><b>006945 Storage JBOD 12 II <sup>1)</sup></b> Storage extension, 2 RU rack-mount, for up to 12 hard disks, RAID 6, 1x cable SFF-8088, 2x redundant power supplies, without hard disk drives</p>
	<p><b>006946 Storage JBOD 24 II <sup>1)</sup></b> Storage extension, 4 RU rack-mount, for up to 24 hard disks, RAID 6, 1x cable SFF-8088, 2x redundant power supplies, without hard disk drives</p>
	<p><b>006949 Storage JBOD 44 II <sup>1)</sup></b> Storage extension, 4 RU rack-mount, for up to 44 hard disks, RAID 6, 1x cable SFF-8088, 2x redundant power supplies, without hard disk drives</p>
Network Contacts	
	<p><b>005142 DLC - Ethernet I/O Interface</b> License for the use of the software interface for the connection of the Ethernet I/O interfaces MOXA ioLogik E1210 (16 contacts), E1212 (8 contacts, 8 DIOs) or E1214 (6 contacts, 6 relays)</p>
	<p><b>001739 Remote Ethernet I/O Interface</b> Ethernet I/O Interface, 2x Ethernet, 6x contacts, 6x relays (MOXA ioLogik E1214)</p>
Power Supply Unit	
	<p><b>004064 Power Supply Unit DPM-150W</b> Power supply module 150 W, 115/230 V AC ±5%, 50/60 Hz (Three power supply modules already included in the scope of delivery)</p>

<sup>1)</sup> The appliance and the Storage JBOD must each be equipped with at least 6 identical SATA hard disks to ensure the required storage speed. The JBOD system has its own RAID system. A RAID array with the internal hard disks of the appliance is not supported.

SeMSy® Recording Server for the recording of up to 120 video streams,  
MK2 revision, 3 RU rack-mount, storage system with 8x 3.5" HDD

## Included Licenses

### DLC - 8 Recording Channels

License for the recording of 8 high-resolution video streams

### DLC - 2 Client Access

License for the simultaneous access of two SeMSy® Compact clients with basic functions to SeMSy® Recording Server (floating license)

### DLC - SEDOR® Camera Sabotage Protection

License for detection and reporting of covering, defocusing and twisting of cameras

### DLC - SmartBackfill

License for the storage of video streams that have been buffered by Dallmeier network cameras with EdgeStorage (not available in combination with DLC - Bank Package and for cameras with recording mode Contact)

### DLC - SNMP

License for integration into a central SNMP device management system

### DLC - SeMSy® III and 5 Flat

License for integration into a SeMSy® III or HEMISPHERE® SeMSy® 5 Video Management System

### DLC - Multicast Streaming

License for the transmission of video streams via multicast in a SeMSy® Video Management System

### DLC - Multicast Recording

License for the recording of video streams of Dallmeier network cameras transmitting via multicast

### DLC - Real-Time Recording

License for real-time recording for all video streams (depending on the camera)

### DLC - RAID 6

License for the recording with RAID 6

### DLC - Data Protection and Data Security

Basic license for use of the integrated data protection and data security module (GDPR-compliant)

## Included Support and License Interval

### IPS 10000 Support and License Interval Basic

License for the use of the support services of the Support Level Basic for 60 months.  
License for the use of the comfort functions Timeline, Interval Jumps and SmartFinder with SeMSy® Compact Clients for 12 months.  
License for the use of the extensions AutoTracking, Pixelation and Dashboard (separate license required) with SeMSy® Compact Clients for 12 months.  
License for the update of operating system and SeMSy® Recording Server with updates, upgrades and security updates<sup>2)</sup> for 12 months.  
Bring-in warranty (without hard disk drives) for 24 months.

## Optional Support and License Interval

### 008271 IPS 10000 Support and License Interval Premium (Plus 12 Months)

License for the use of the support services of the Support Level Premium for 12 months.  
License for the use of the comfort functions Timeline, Interval Jumps and SmartFinder with SeMSy® Compact Clients for 12 months.<sup>3)</sup>  
License for the use of the extensions AutoTracking, Pixelation and Dashboard (separate license required) with SeMSy® Compact Clients for 12 months.<sup>3)</sup>  
License for the update of operating system and SeMSy® Recording Server with updates, upgrades and security updates<sup>2)</sup> for 12 months.

### 008272 IPS 10000 Support and License Interval Premium and Warranty (Total of 60 Months)

License for the use of the support services of the Support Level Premium for 60 months.  
Unlimited license for the use of the comfort functions Timeline, Interval Jumps and SmartFinder with SeMSy® Compact Clients.  
Unlimited license for the use of the extensions AutoTracking, Pixelation and Dashboard (separate license required) with SeMSy® Compact Clients.  
License for the update of operating system and SeMSy® Recording Server with updates, upgrades and security updates<sup>2)</sup> for 60 months.  
Extension of the bring-in warranty (without hard disk drives) from 24 months to a total of 60 months.

2) Security updates for relevant CVE vulnerabilities that become known will be provided (subject to technical feasibility) for the entire term of the software maintenance.  
3) After a gap-free Premium licensing period of 60 months, the comfort functions and extensions can be used with SeMSy® Compact Clients for an unlimited period of time.

SeMSy® Recording Server for the recording of up to 120 video streams,  
MK2 revision, 3 RU rack-mount, storage system with 8× 3.5" HDD

Optional Licenses (Access)	
003782	<b>DLC - 1 Additional Client Access</b> License for the use of simultaneous access with basic functions by an additional SeMSy® Compact client to SeMSy® Recording Server (floating license)
004068	<b>DLC - 5 Additional Client Access</b> License for the use of simultaneous access with basic functions by five additional SeMSy® Compact clients to SeMSy® Recording Server (floating license)
004069	<b>DLC - 10+ Additional Client Access (unlimited)</b> License for the use of simultaneous access with basic functions by an unlimited number of SeMSy® Compact clients to SeMSy® Recording Server, depending on system load and bandwidth (floating license)
Optional Licenses (Channels)	
005754	<b>DLC - 1 Additional Recording Channel (IPS 10 000)</b> License for the use of an additional channel for the recording of one high-resolution video stream, in total maximum 120 video streams
005755	<b>DLC - 3rd Party Package for 1 Recording Channel (IPS 10 000)</b> License for the use of one existing channel for recording (permanent, contact triggered or with motion detection) of third-party network cameras
Optional Licenses (Functions)	
003801	<b>DLC - PRemote-HD</b> License for the transmission of SD and HD video at low bandwidth, including a dedicated access license and the function for access with a mobile app (DMVC Server)
004685	<b>DLC - LAN Interface for Data Reception</b> License for the reception of data from third-party systems (AWEK POS systems and NPC II protocol converters) over the network interface, including linking, storage and display of the data with the video recordings
006293	<b>DLC - High-Speed Recording &gt;30 fps</b> License for the recording of Dallmeier network cameras with a frame rate of more than 30 fps
006899	<b>DLC - ViProxy Plus (IPS 10 000)</b> License for the use of the second network interface in combination with one of the functions ViProxy (physically separated network for cameras, including WebConfig routing), Link Redundancy (redundant connection of the appliance to two switches) or Data Throughput (bundling of both network interfaces to one channel with double data throughput)
Optional Licenses (Extensions SeMSy® Compact)	
007238	<b>DLC - SC AutoTracking for Single Sensor Camera</b> License for the use of the SeMSy® Compact AutoTracking function (multiple object tracking without loss of the overall image) in conjunction with a Dallmeier network camera with VCA support, only in connection with recording systems with a valid license for the use of comfort functions and maintenance
007239	<b>DLC - SC AutoTracking for Panomera® S/W 4</b> License for the use of the SeMSy® Compact AutoTracking function (multiple object tracking without loss of the overall image) in conjunction with a Panomera® S/W 4 system with VCA support, only in connection with recording systems with a valid license for the use of comfort functions and maintenance
007237	<b>DLC - SC AutoTracking for Panomera® S/W 8</b> License for the use of the SeMSy® Compact AutoTracking function (multiple object tracking without loss of the overall image) in conjunction with a Panomera® S/W 8 system with VCA support, only in connection with recording systems with a valid license for the use of comfort functions and maintenance
008021	<b>DLC - Client AI Pixelation</b> License for the use of Pixelation AI Server Software in combination with Dallmeier Client Software for pixelation of persons during the display of a video stream, valid license for the use of comfort functions and maintenance required
007092	<b>DLC - SC Dashboard Support</b> License for the use of the SeMSy® Compact Dashboard function (graphical display of the analysis data Line Crossing, Intrusion Detection and Object Counting including object types), only in connection with Dallmeier network cameras and Panomera® systems with VCA support, only in connection with recording systems with a valid license for the use of comfort functions and maintenance

SeMSy® Recording Server for the recording of up to 120 video streams,  
MK2 revision, 3 RU rack-mount, storage system with 8× 3.5" HDD

Components	
CPU	Multi-Core
RAM	16 GB
Flash module	128 GB (for operating system and application)
Hard disks	Up to 8× 3.5" HDD (optional, see HDD whitelist, min. 7200 rpm and 128 MB cache)
Storage capacity	Currently up to 108TB (RAID 6, 90% video stream storage, 10% EdgeAnalytics database)
Fan	3× with automatic speed adaptation
Power supply unit 1	Integrated
Power supply unit 2	Integrated
Power supply unit 3	Integrated (required for redundant operation)
Interfaces	
Video OUT	1× DisplayPort, only for configuration 1× HDMI, only for configuration 1× DVI, only for configuration
AUX/ Line IN	1× 3.5 mm phone jack
Microphone IN	1× 3.5 mm phone jack (for intercom, license 003801 required)
Audio OUT	1× 3.5 mm phone jack (for intercom, license 003801 required)
USB	1× USB 3.1 gen. 2 type A (rear side) 1× USB 3.1 gen. 2 type C (rear side) 2× USB 3.1 gen. 1 type A (rear side) 1× USB 2.0 type A (front side)
Ethernet 1	RJ45, 10/100/1000 Mbps
Ethernet 2	RJ45, 10/100/1000 Mbps (optional, license 006899 - DLC - ViProxy Plus required)
Contact IN	4×, with galvanic isolation, only for switch / push button (dry contact), with 4 functions each
Relay OUT	4×, with galvanic isolation, max. 12V DC / 24V AC / 0.5A, 150 mOhm, as NC or NO
SATA interface	RAID controller board for JBOD storage extension (optional)
Protocols	
Ethernet protocols	IPv4 (ARP, ICMP, IGMPv2/IGMPv3), UDP, TCP
Ethernet protocols in preparation	IPv6 (NDP, ICMPv6, MLDv1/MLDv2, SLAAC, RDNSS), UDPv6, TCPv6, SNMPv3
Communication protocols	DaVid, DaVidS, HTTP, HTTPS <sup>4)</sup> , DNS, DHCP, LDAP, NTP, RTSP, RTP, RTCP, SNMP (v1, v2c)
Security	HTTPS <sup>4)</sup> encryption, SSL/TLS <sup>4)</sup> 1.2 (AES), network access control according to IEEE 802.1X <sup>4)</sup>
Electrical Data	
Voltage supply	115/230 V AC ±5%, 50/60 Hz
Power consumption	Max. 230 W
Thermal output	Max. 785 BTU/h
Mechanical Data	
Dimensions (W × H × D)	Approx. 483 × 133 × 533 mm (19.0" × 5.3" × 21.0")
Weight	Approx. 20 kg (44 lb) with eight hard disks
Color	Black (front, anodized)
Ambient Data	
Temperature	+ 5°C up to +40°C (41°F – 104°F)
Recommended temperature	+20°C up to + 25°C (68°F – 77°F)
Humidity	5 – 70% RH, non-condensing
Atmospheric load	Dust-free
Approvals and Certifications	
Type	CE, FCC, RCM, UL, LGC Forensics

4) This product includes software developed by the OpenSSL Project for use in the OpenSSL Toolkit (<http://www.openssl.org>) and cryptographic software written by Eric Young ([ey@cryptsoft.com](mailto:ey@cryptsoft.com)).

SeMSy® Recording Server for the recording of up to 120 video streams,  
MK2 revision, 3 RU rack-mount, storage system with 8x 3.5" HDD

Software	
Operating system	Linux (proprietary, hardened)
Application	SeMSy® Recording Server (version 10.x.x)
Application language	English, German, French, Spanish, Italian (others on request)
External client software	HEMISPHERE® SeMSy® Compact/Workstation Software, SeMSy® III Workstation Software, DMVC App (optional, license 003801 - DLC - PRemote-HD required)
External configuration software	Dallmeier Device Manager
ONVIF compliance	Cameras with Profile S and Profile T supported
GDPR compliance	Supported

Performance in connection with IPS 10 000	
Channels	Up to 120x high-resolution video streams
Supported cameras	Dallmeier Panomera® multifocal sensor systems Dallmeier network cameras over TCP/DaVid (Dallmeier video protocol) Third-party network cameras with RTSP streaming over UDP/RTP or TCP (optional, license 005755 - DLC - 3rd Party Package required)
Track mode	Automatic
Video compression	H.264, H.265, MJPEG, depending on the camera
Audio compression	G.711, G.722.1, depending on the camera
Resolutions	Up to 12 MP, depending on the camera
Frame rate per channel	Up to 25/30 fps, depending on the camera
Bit rate per channel	Up to 50 Mbps, depending on the camera
Max. total bit rate	Up to 480 Mbps

Recording <sup>5)</sup>	3rd Party IP Camera	Dallmeier IP Camera
Transport protocol	RTP over UDP	TCP
Communications protocol	RTSP	DaVid
Mode Timer	integrated	integrated
Mode Permanent	integrated	integrated
Mode Contact	integrated	integrated
Mode Motion	integrated	integrated
Mode Motion/Contact	integrated	integrated
Switching mode by timer	--	integrated

Functions <sup>5)</sup>	3rd Party IP Camera	Dallmeier IP Camera
Motion detection	integrated	integrated
SmartFinder	integrated	integrated
Video proxy	integrated	integrated
SeMSy® multicast streamer	integrated	integrated
PRemote-HD	integrated	integrated
DMVC Server	integrated	integrated
PTZ control with SeMSy® Compact	integrated	integrated
Audio recording	integrated <sup>6)</sup>	integrated
Camera configuration	integrated	integrated
Locking the camera configuration	--	integrated
Recording multicast video streams	--	integrated
EdgeStorage&SmartBackfill	--	integrated
Network scan (IP Finder)	--	integrated
EdgeAnalytics database	--	integrated

5) Data refer to a fully equipped appliance. Optional licenses are required.

6) Depending on the camera. The audio stream must be delivered in G.711 format.

# IPS 10 000

MK2

SeMSy® Recording Server for the recording of up to 120 video streams,  
MK2 revision, 3RU rack-mount, storage system with 8x 3.5" HDD

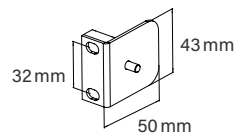
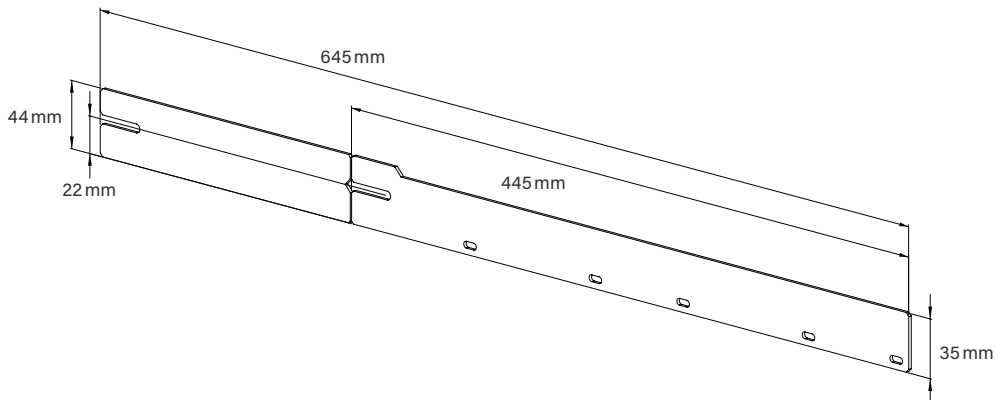
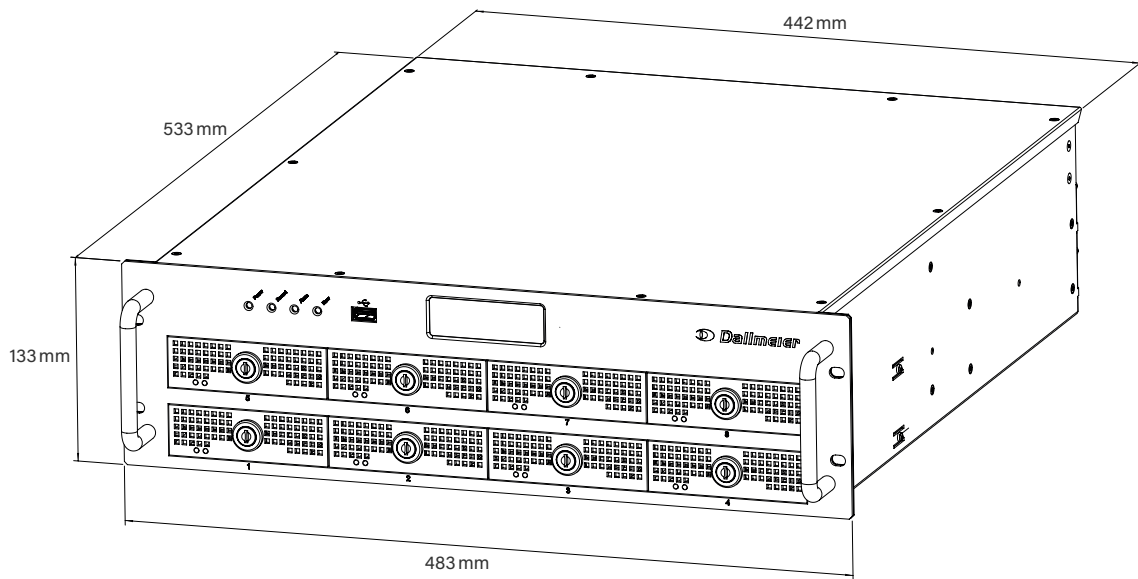

Dallmeier electronic GmbH & Co.KG | Bahnhofstr. 16, 93047 Regensburg, Germany | +49 941 8700-0 | dallmeier.com

All trademarks identified by \* are registered trademarks of Dallmeier electronic GmbH & Co.KG.

Third-party trademarks are named for information purposes only. Dallmeier electronic respects the intellectual property of third parties and always attempts to ensure the complete identification of third-party trademarks and indication of the respective holder of rights. In case that protected rights are not indicated separately, this circumstance is no reason to assume that the respective trademark is unprotected.

Specifications subject to change without notice. Errors and misprints excepted. Pictures may differ from the actual product.



See more.