

DMS 2400 II

SMAVIA appliance for the recording of up to 24 video streams, stand-alone, 3 RU, 2x 3.5" HDD

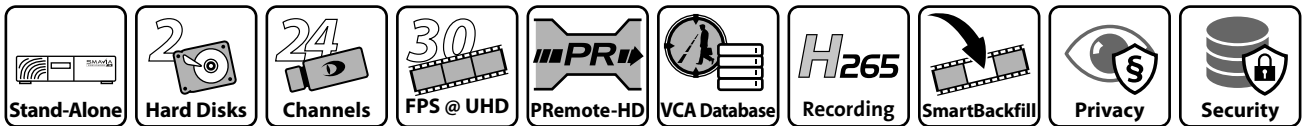

The DMS 2400 II is a high-performance appliance with a processing capacity for up to **24 video streams**. In combination with the dedicated software **SMAVIA Recording Server**, it is ideally suited for all applications that require high recording speed and low power consumption with maximum data security.

SMAVIA Viewing Client

SMAVIA Viewing Client allows independent and convenient evaluation of the recordings over the network. The software can be installed on workstations with Windows operating system and adjusted individually. **Two licenses** for access with clients are already **included in the scope of delivery** of the appliance.

SeMSy® Integration

The appliance is factory fitted with the **SeMSy® Flat** license. Thus, it is optimally equipped for integration into the storage system of a **SeMSy® Video Management System**. The appliance supports the complete SeMSy® functional range including convenient evaluation of recordings on a SeMSy® Workstation.

PRemote-HD

The optional **PRemote-HD** function transcodes high-definition video streams (live and playback) for **transmission in low-bandwidth networks**. It allows the resource-conserving access with SeMSy® or SMAVIA Viewing Client which is independent of the recording settings. This license also includes the **DMVC Server** function for access with the mobile **Dallmeier Mobile Video Center** application.

VCA Data Base

The appliance is equipped with a **database** for the analysis results of Dallmeier **network cameras with VCA technology**. The **events, objects and classes** sent by the camera are **stored** with the relevant metadata **almost in real-time**. **SMAVIA Viewing Client** is available for the targeted **search and evaluation** of the events with the **SmartFinder** function.

Open Platform

The pre-installed **SMAVIA Recording Server** software is designed as an open platform. Together with the according licenses, **third-party network cameras** can be recorded with **motion detection** and configured over the **ONVIF protocol**.

Features Hardware









- High performance server hardware
- Flash module for operating system and application
- High memory speed due to matched components
- Components optimized for SMAVIA Recording Server
- Mounting rails for 19" rack optional

Features SMAVIA Recording Server

- Recording of up to 24 high-resolution video streams
- Licenses for the recording of 8 video streams included
- Licenses for access with 2 clients included
- Licenses for the update of the software for 12 months included
- License for SEDOR® Camera Sabotage Protection included
- License for SmartBackfill included
- License for multicast recording included
- Recording of third-party network cameras optional
- Evaluation with DMVC App over WAN/LAN optional
- Evaluation with SMAVIA or SeMSy® over WAN/LAN
- Basic license for integrated data protection and data security module (GDPR-compliant) included

DMS 2400 II

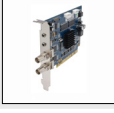
SMAVIA appliance for the recording of up to 24 video streams,
stand-alone, 3 RU, 2× 3.5" HDD

Appliance	
005959	 DMS 2400 II SMAVIA appliance for the recording of up to 24 video streams, licenses for the recording of 8 video streams included, licenses for the access with 2 clients included, without HDDs
Options Hardware	
000178	Mounting of a HDD Mounting of a HDD, incl. function-, long-term-, and final test, acceptance and approval
006664	 HDD 2000 GB, SATA, 3.5"
006158	HDD 4000 GB, SATA, 3.5"
006596	HDD 6000 GB, SATA, 3.5"
006632	HDD 8000 GB, SATA, 3.5"
006961	HDD 10000 GB, SATA, 3.5"
006962	HDD 12000 GB, SATA, 3.5"
004429	 DVD-RW Drive SATA (Teac) Writer DVD-RW, SATA, slimline, tray load (ex factory)
003877	 DVD-RW Drive SATA (Teac) Retrofit Kit Writer DVD-RW, SATA, slimline, tray load (retrofit kit)
Options Hybrid Upgrade	
003816	 Encoder Board for 8 Analog Channels Encoder board for 8 analog video channels in hybrid operation, incl. Audio IN Adapter, without additional licenses
003815	 Mounting Kit for 24 Analog Channels Extension kit for 24 analog channels, 1× BNC Video IN Panel, 1× internal Coax cable set, 2× cable fittings, UTC-24 module (ex factory only)
004150	 CVBS OUT for DMS 2400 CVBS output for the connection of up to 2 analog monitors, 2× BNC
Option Network Contacts	
005142	DLC - Ethernet I/O Interface for SMAVIA License for the use of the software interface for the connection of the Ethernet I/O interfaces MOXA ioLogik E1210 (16 contacts), E1212 (8 contacts, 8 DIOs) or E1214 (6 contacts, 6 relays)
001739	 Remote Ethernet I/O Interface Ethernet I/O Interface, 2× Ethernet, 6× contact, 6× relay (MOXA ioLogik E1214)
Option Bracket	
000010	 19 Inch Bracket (DMS, DVS, PVS IV, PVS 7) Bracket for mounting the device in a 19" rack

DMS 2400 II

SMAVIA appliance for the recording of up to 24 video streams,
stand-alone, 3 RU, 2× 3.5" HDD

Included Licenses

DLC - 8 Recording Channels

License for the recording of 8 high-definition video streams

DLC - 2 Client Access

License for the simultaneous access of two clients to SMAVIA Recording Server (floating license)

DCP - Software Maintenance 12 Months

License for the update of the SMAVIA software for 12 months

DLC - SEDOR® Camera Sabotage Protection

License for detection and reporting of covering, defocusing and twisting of cameras

DLC - SmartBackfill

License for the storage of video streams that have been buffered by Dallmeier network cameras with EdgeStorage (not available in combination with DLC - Bank Package and for cameras with recording mode Contact)

DLC - SNMP

License for the integration into a central SNMP device management system

DLC - SeMSy® Flat

License for the integration into a SeMSy® Video Management System

DLC - Multicast Streaming

License for the transmission of video streams via multicast in a SeMSy® Video Management System

DLC - Multicast Recording

License for the recording of video streams of Dallmeier network cameras using multicast transmission

DLC - Real-Time Recording

License for real-time recording for all video streams (depending on the camera)

DLC - LocalViewing

License for the use of the integrated video player for the local playback of one camera (analog, SD IP or HD IP) and the local live display of several cameras in a multi-split (analog, SD IP and HD IP)

DLC - Data Protection and Data Security

Basic license for use of the integrated data protection and data security module (GDPR-compliant)

Optional Licenses (Access)

003782 **DLC - 1 Additional Client Access**
License for the simultaneous access of a further client on SMAVIA Recording Server (floating license)

004068 **DLC - 5 Additional Client Access**
License for the simultaneous access of five further clients on SMAVIA Recording Server (floating license)

004069 **DLC - 10+ Additional Client Access (unlimited)**
License for the simultaneous access of an unlimited number of clients on SMAVIA Recording Server, depending on system load and bandwidth (floating license)

Optional Licenses (Channels)

007640 **DLC - 1 Additional Recording Channel (IPS/DMS 2400 II)**
License for the recording of a further high-definition video stream, maximum 24 video streams in total

007679 **DLC - 3rd Party Package for 1 Recording Channel (IPS/DMS 2400 II)**
License for the use of one existing channel for the recording (permanent, contact triggered or with motion detection) of third-party network cameras

DMS 2400 II

SMAVIA appliance for the recording of up to 24 video streams,
stand-alone, 3 RU, 2× 3.5" HDD

Optional Licenses (Functions)	
007923	DLC - RAID 1 Recording (DMS 2400 II) License for the recording with RAID 1 in combination with two identical hard drives (HDDs) ¹⁾
003801	DLC - PRemote-HD License for the transmission of SD and HD video with low bandwidth, including a dedicated access license ²⁾ as well as the function for access with a mobile app (DMVC Server)
003806	DLC - Audio Recording for All Analog Channels License for the use of audio recordings for all analog channels (hardware 003815 and 003816 required) ³⁾
004685	DLC - LAN Interface for Data Reception License for the reception of the data from third-party systems (AWEK cash desk systems and NPC II protocol converter) over the network interface; linking, storing and displaying the data with the video recordings included
006293	DLC - High-Speed Recording >30 fps License for the recording of Dallmeier network cameras with a frame rate of more than 30 fps
007642	DLC - ViProxy Plus (IPS/DMS 2400 II) License for the use of the second network interface in conjunction with one of the functions ViProxy (physically separated network for cameras, WebConfig Routing included), Link Redundancy (redundant connection of the appliance to two switches) or Data Throughput (bundling of both network interfaces to a channel with double data throughput)
007652	DLC - Bank Package (DMS 2400 II) License for the use of the DGUV Test-compliant recording module, ATM activity monitoring and reference image transmission via e-mail included
Maintenance and Warranty	
007643	DCP - SW Maintenance 12 Months (IPS/DMS 2400 II) License for the update of the SMAVIA software for further 12 months, maximum 60 months in total
007644	DCP - HW Warranty and SW Maintenance 36 Months (IPS/DMS 2400 II) Extension of the bring-in warranty period (without HDDs) to 36 months in total, and extension of the license for the update of the SMAVIA software to 36 months in total
007645	DCP - HW Warranty and SW Maintenance 48 Months (IPS/DMS 2400 II) Extension of the bring-in warranty period (without HDDs) to 48 months in total, and extension of the license for the update of the SMAVIA software to 48 months in total
007646	DCP - HW Warranty and SW Maintenance 60 Months (IPS/DMS 2400 II) Extension of the bring-in warranty period (without HDDs) to 60 months in total, and extension of the license for the update of the SMAVIA software to 60 months in total

1) When using the RAID configuration, a connection to a UPS is necessary.

2) The first PRemote client (master) is assigned active control over the PRemote stream; further PRemote clients (slaves) receive the stream passively.

3) Audio playback with SMAVIA Viewing Client over the network. Local audio playback with LocalViewing is not supported.

DMS 2400 II

SMAVIA appliance for the recording of up to 24 video streams,
stand-alone, 3 RU, 2× 3.5" HDD

Components	
CPU	Multi-Core
RAM	8 GB
Flash module	8 GB (for operating system and application)
Hard disks	Up to 2× 3.5" HDD (optional, note HDD whitelist, min. 7200 rpm and 128 MB cache)
Max. storage capacity	Currently up to 24 TB (without RAID)
Fan	3× with automatic speed adaptation
Power supply unit	Integrated

Interfaces	
Video IN analog	24× CVBS/BNC, with loop-through (optional, Mounting Kit 003815)
Video OUT	2× DisplayPort 1× DVI 2× CVBS/BNC (optional, Board 004150)
AUX / Line IN	1× 3.5 mm phone jack
Microphone IN	1× 3.5 mm phone jack (for intercom, license 003801 required)
Audio OUT	1× 3.5 mm phone jack (for intercom, license 003801 required)
USB	2× USB 3.0 type A (rear side) 5× USB 2.0 type A (rear side) 1× USB 2.0 type A (front side)
Ethernet 1	RJ45, 10/100/1000 Mbps
Ethernet 2	RJ45, 10/100/1000 Mbps (optional, license DLC - ViProxy Plus (007642) required)
Contact IN	30×, with galvanic isolation, only for switch / push button (dry contact), with 4 functions each
Relay OUT	5×, with galvanic isolation, max. 12 V DC / 24 V AC / 0,5 A, 150 mOhm, as NC or NO
Serial	2× RS232
PS/2	Mouse, keyboard

Protocols	
Ethernet protocols	IPv4 (ARP, ICMP, IGMPv2/IGMPv3), UDP, TCP
Ethernet protocols in preparation	IPv6 (NDP, ICMPv6, MLDv1/MLDv2, SLAAC, RDNSS), UDPv6, TCPv6
Communication protocols	DaVid, DaVidS, HTTP, HTTPS ⁴⁾ , DNS, DHCP, LDAP, NTP, RTSP, RTP, RTCP, SNMP (v1, v2c)
Security	HTTPS ⁴⁾ encryption, SSL/TLS ⁴⁾ 1.2 (AES), network access control according to IEEE 802.1X ⁴⁾

Electrical Data	
Voltage supply	115/230 V AC ±5%, 50/60 Hz
Power consumption	Max. 145 W (operation without encoder board for analog channels) Max. 170 W (operation with 3 encoder boards for 24 analog channels in total)
Thermal output	Max. 580 BTU/h

Mechanical Data	
Dimensions (W × H × D)	Approx. 425 × 130 × 446 mm (16.7" × 5.1" × 17.6") with feet Approx. 425 × 122 × 446 mm (16.7" × 4.8" × 17.6") without feet
Weight	Approx. 12 kg (26 lb) with 2 hard disks
Color	Black (anodized)

Ambient Data	
Temperature	+ 5°C up to +40°C (41°F – 104°F)
Recommended temperature	+20°C up to + 25°C (68°F – 77°F)
Humidity	5 – 70% RH, non-condensing
Atmospheric load	Dust-free

Approvals and Certifications	
Type	CE, UL, FCC, RCM, LGC Forensics, DIN EN 50130-4

4) This product includes software developed by the OpenSSL Project for use in the OpenSSL Toolkit (<http://www.openssl.org>) and cryptographic software written by Eric Young (ey@cryptsoft.com).

DMS 2400 II

SMAVIA appliance for the recording of up to 24 video streams,
stand-alone, 3 RU, 2x 3.5" HDD

Software	
Operating system	Linux (proprietary, hardened)
Application	SMAVIA Recording Server (version 9.x.x)
Application language	English, German, French, Spanish, Italian (others on request)
External management software	SMAVIA Viewing Client DMVC App (optional, license DLC - PRemote-HD (003801) required)
External configuration software	PService3
ONVIF compliance	Profile S
GDPR compliance	Supported

Performance in connection with DMS 2400 II	
Channels	Up to 24x high definition video streams
Supported cameras	Dallmeier Panomera® multifocal sensor systems Dallmeier network cameras over TCP/DaVid (Dallmeier video protocol) Third-party network cameras with RTSP streaming over UDP/RTP or TCP (optional, license 007641 required) Analog cameras (optional, mounting kit (003815), encoder card 1 to 3 (003816), licenses for channels 9 to 24 required)
Track mode	Automatic
Video/Audio compression	H.264, H.265 / G.722.1
Resolutions	Up to 12 MP, depending on the camera
Frame rate per channel	Up to 25/30 fps, depending on the camera
Bit rate per channel	Up to 50 Mbps, depending on the camera
Max. total bit rate	Up to 144 Mbps

Optional analog cameras				
Resolutions	Up to 4CIF (704 x 576), depending on the camera			
Frame rate per channel	6,25 / 12,5 / 25 fps @ CIF 6,25 / 12,5 fps @ 4CIF 25 fps @ 4CIF in combination with 2 analog channels:			
	Encoder Board 1	Encoder Board 2	Encoder Board 3	
Usable analog channels	1, 3, 5, 7	9, 11, 13, 15	17, 19, 21, 23	
Usable additional IP channels	2, 4, 6, 8	10, 12, 14, 16	18, 20, 22, 24	

Recording ⁵⁾	3rd Party IP Camera	Dallmeier IP Camera
Transport protocol	RTP over UDP	TCP
Communications protocol	RTSP	DaVid
Mode Timer	integrated	integrated
Mode Permanent	integrated	integrated
Mode Contact	integrated	integrated
Mode Motion	integrated	integrated
Mode Motion/Contact	integrated	integrated
Switching mode by timer	--	integrated

Functions ⁵⁾	3rd Party IP Camera	Dallmeier IP Camera
Motion detection	integrated	integrated
SmartFinder	integrated	integrated
Video proxy	integrated	integrated
SeMSy® multicast streamer	integrated	integrated
PRemote-HD	integrated	integrated
DMVC Server	integrated	integrated
PTZ control with SVC	integrated	integrated
Audio recording	integrated ⁶⁾	integrated
Camera configuration	integrated	integrated
Locking the camera configuration	--	integrated
Recording multicast video streams	--	integrated
EdgeStorage&SmartBackfill	--	integrated
Network scan (IP Finder)	--	integrated
VCA data base	--	integrated

5) Data refer to a fully equipped appliance. Optional licenses are required.

6) Depending on the camera. The audio stream has to be supplied in the format G.711.

DMS 2400 II

SMAVIA appliance for the recording of up to 24 video streams,
stand-alone, 3 RU, 2x 3.5" HDD

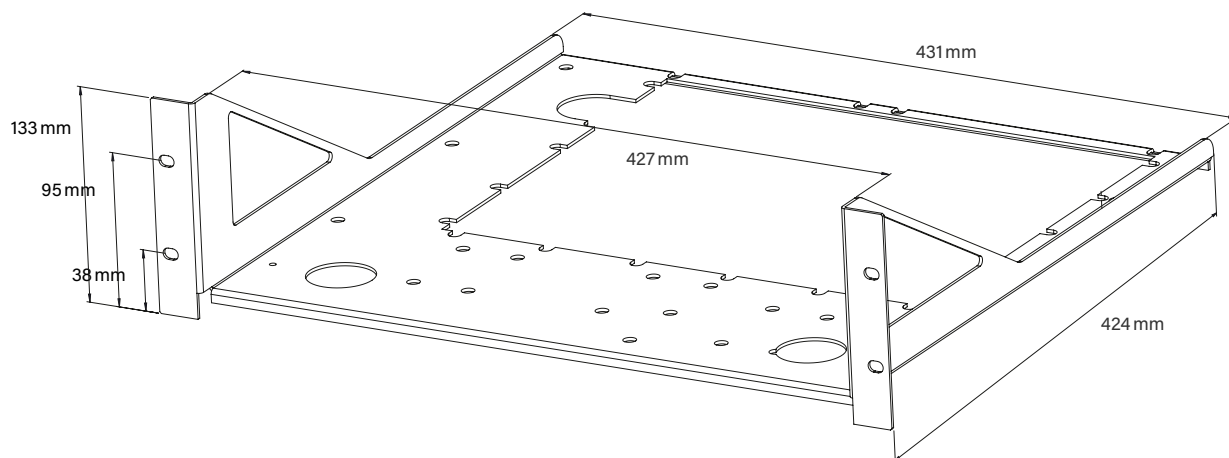
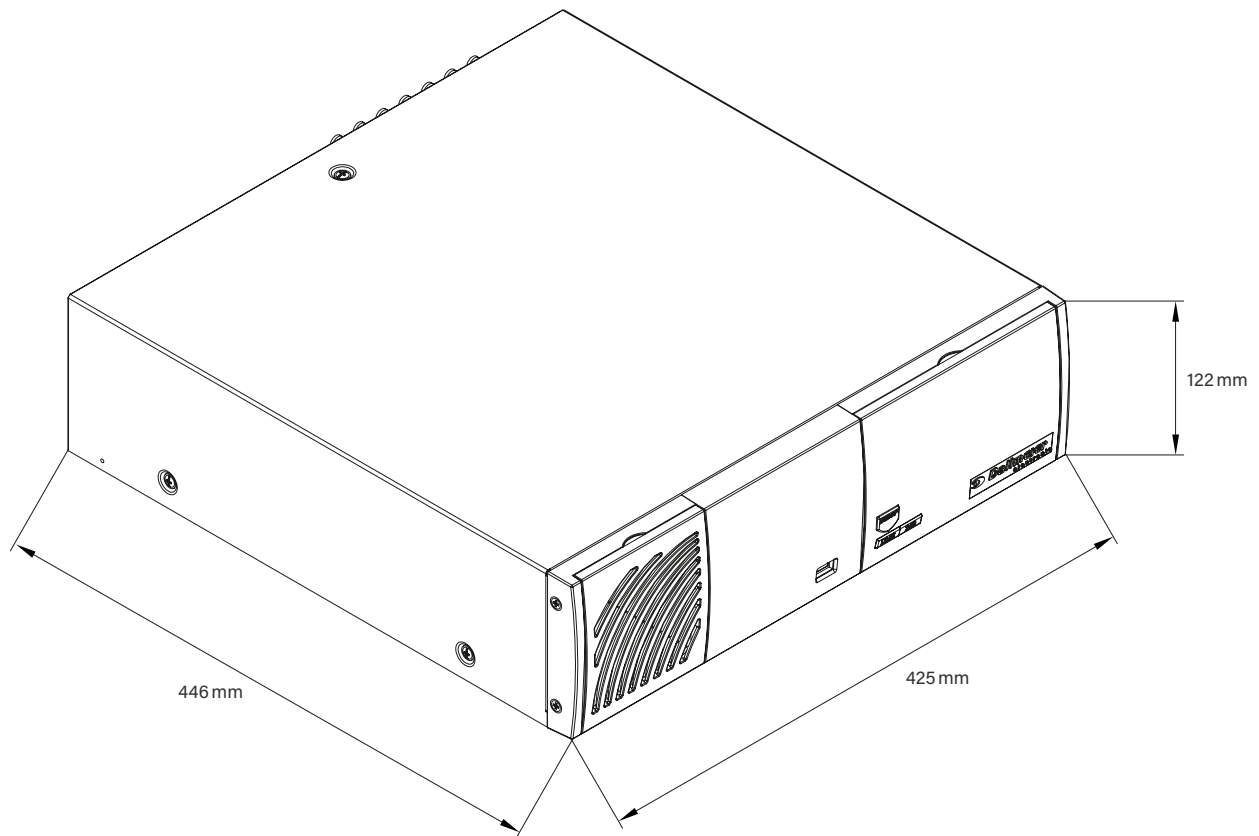

Dallmeier electronic GmbH & Co.KG | Bahnhofstr. 16, 93047 Regensburg, Germany | +49 941 8700-0 | dallmeier.com

All trademarks identified by * are registered trademarks of Dallmeier electronic GmbH & Co.KG.

Third-party trademarks are named for information purposes only. Dallmeier electronic respects the intellectual property of third parties and always attempts to ensure the complete identification of third-party trademarks and indication of the respective holder of rights. In case that protected rights are not indicated separately, this circumstance is no reason to assume that the respective trademark is unprotected.

Specifications subject to change without notice. Errors and misprints excepted. Pictures may differ from the actual product.



See more.